

07.1-100 Adjustment of idle speed and idle speed adjuster

Job no. of flat rates or standard texts and flat rates data 07-2053.

Testing and adjusting values USA

Standard version and

Model	Engine	Idle speed 1/min
116.1	617.95	700-800
123.1		
126.1		

Conventional tester

Digital tester

e.g. Bosch, MOT 001.03

Note

Models 116 and 126 are provided with a revolution counter as standard equipment.

The revolution counter is activated via the transmitter adapter in the diagnostic socket. The adapter for the TDC transmitter clips into the cap on the diagnostic socket.

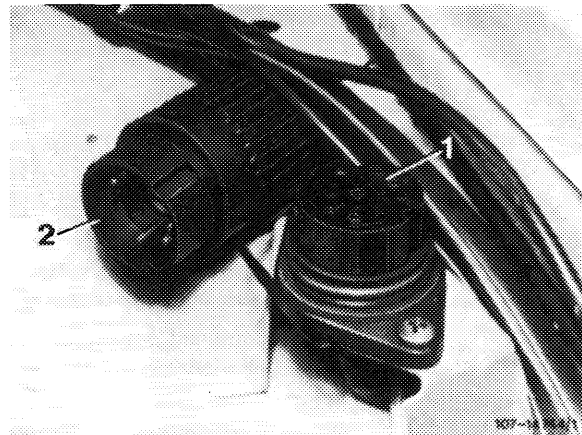

- 1 Diagnostic socket
- 2 TDC transmitter adapter

Do not adjust idle speed when engine is too hot, e.g. immediately following a fast drive or after measuring output on output dynamometer.

Model 116

Circuit diagram
Revolution counter

- 1 Adapter for TDC transmitter
- 2 TDC transmitter
- 3 Revolution counter
- 4 Cable connector
- a to warning lamp, brake lining/pad wear indicator
- b to terminal 15 (fuse No. 4)
- c protection device

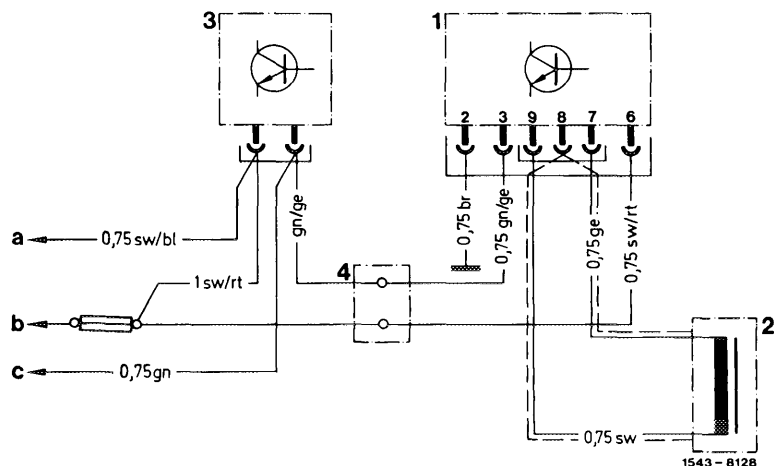

Models 123, 126
Circuit diagram
Revolution counter

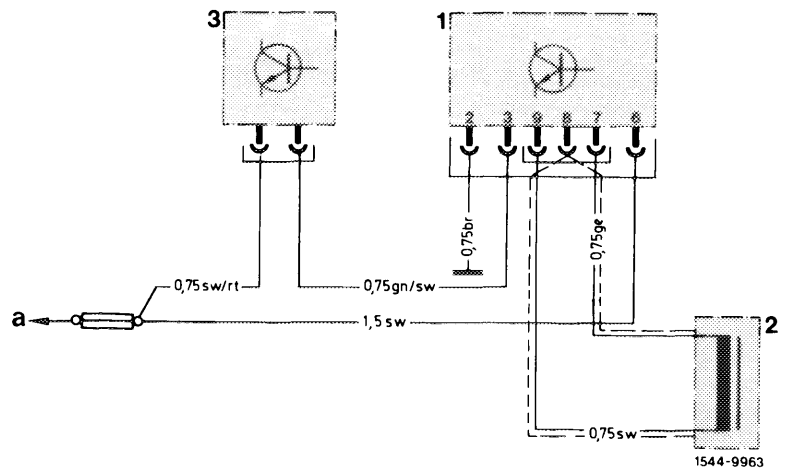

- 1 Adapter for TDC transmitter
- 2 TDC transmitter
- 3 Revolution counter
- 4 Cable connector

a To terminal 15 (fuse no. 12)

Adjustment

- 1 Switch off air-conditioner or automatic climate control. Move selector lever to position "P".
- 2 Connect digital tester to diagnostic socket.
- 3 Check control linkage for ease of movement and wear.
- 4 Run engine to 60–80 °C coolant temperature.

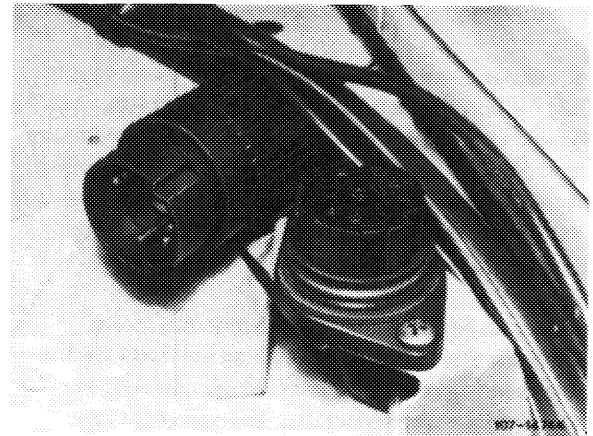

- 5 On model 116 up to model year 1979, turn idle speed adjuster completely to the right and check distance between nipple and clip on contour spring and adjust, if required. Nominal dimension = approx. 1.0 mm.

Attention:

Check whether the special form spring is fitted correctly. To do so, turn rotary knob back to left; free movement to point where idle speed rises again must not exceed approx. 1/2 turn. If necessary, adjust at screw (2).

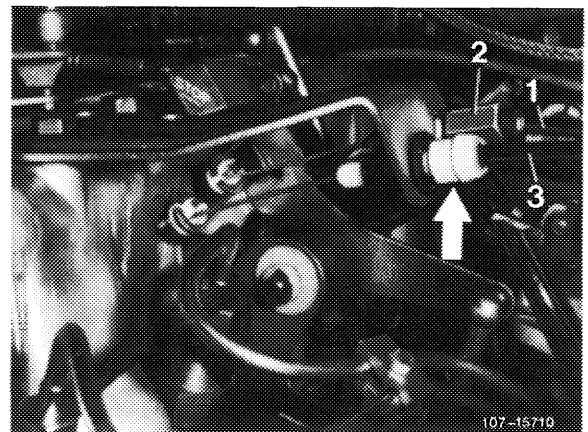

- 1 Bowden control cable for idle speed adjuster
- 2 Adjusting screw
- 3 Bowden wire for cruise control/tempomat

- 1 Control cable for idle speed correction
- 2 Special form spring
- 3 Nipple
- 4 Bell crank

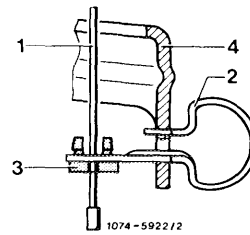

6 Adjust tempomat (cruise control)

a) Adjust bowden wire for tempomat (cruise control). For his purpose, push shutoff lever up to stop, with bowden wire resting free of tension against regulating lever. Adjust bowden wire with adjusting nut (arrow), if required. Release shutoff lever (idle speed position). In this position, bowden wire is subject to play.

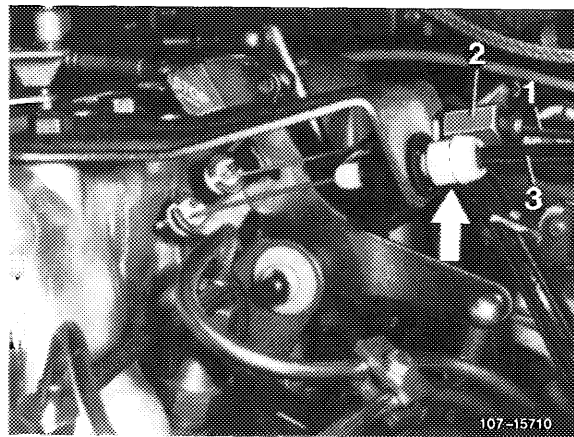

b) Adjust connecting rod for tempomat (cruise control). Check whether adjusting link rests against idle speed stop of tempomat (cruise control). For this purpose, disconnect connecting rod (21) and push lever of adjusting link (4) clockwise against idle speed stop. When attaching connecting rod (21) make sure that the lever of the adjusting link is pushed away from idle speed stop by approx. 1 mm. Adjust connecting rod, if required.

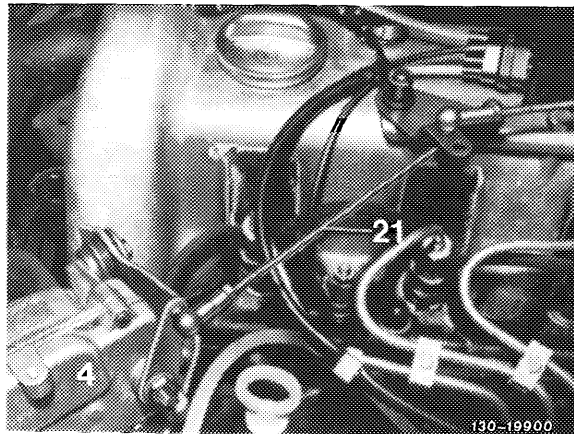

7 Detach connecting rod (2) from bell crank.

8 Check idle speed, loosen counter nut (3), if required, and adjust idle speed by means of idle speed adjusting screw (4) to 700–800/min.

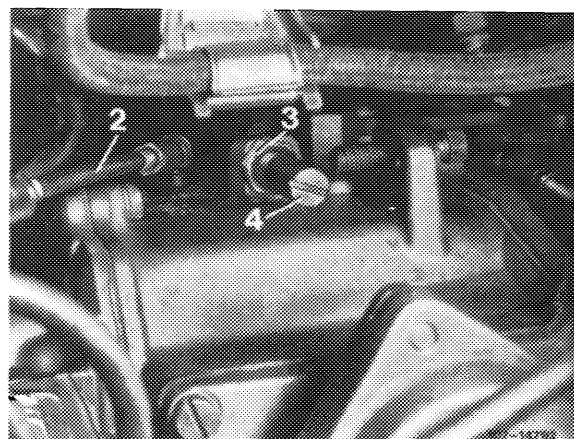

- 2 Connecting rod to bell crank
- 3 Lock-nut
- 4 Idle adjusting screw

9 Attach connecting rod so that it hangs freely. Adjust control linkage if necessary.

10 Move selector lever back to drive position, switch automatic air-conditioner on and turn power steering to full lock, making sure that engine runs smoothly. Adjust speed if necessary.

11 On Model 116 up to model year 1979, accelerate with accelerator pedal while simultaneously turning knob for idle speed adjuster to the left. Speed should now amount to 1000–1100/min. Adjust by means of adjusting screw (2), if required.

Attention:

The idle speed control range will be exceeded if a higher speed is set. The engine speed may then rise to maximum revolutions (at no-load).

